

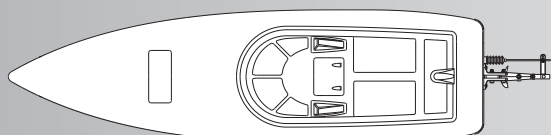

BRUSHLESS MOTOR BOAT

#8301 V4 & #8303 MANUAL

Specifications:



Model No: 8301V4 Bullet V4 Deep Vee

Total Length.....730mm(28.7in)
 Beam.....180mm(7.1in)
 Speed.....60+KPH

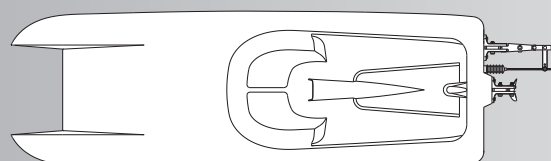

Model No: 8303 Big Storm

Total Length.....730mm(28.7in)
 Beam.....209mm(8.23in)
 Speed.....60+KPH

Universal Assembly:

Motor.....Water cooled 2815 out-runer brushless motor(included)
 Radio System.....2.4G 2CH Digital Proportional Transmitter(Included)
 Speed Control.....Water cooling 60A Brushless ESC w/BEC (Included)
 Drive System..... 4mm Flex Cable Direct Drive
 Propeller.....Three Blade Metal Propeller
 Battery.....Two packs of 7.4V 4000mAh 35C LiPo Pack(Not Included)

Caution for LiPo battery:

ESC with low voltage hard cut off at 3.2V per cell, when driving your boat , as soon as you notice boat stop, that means ESC low voltage cut off effective, you should immediately drive boat back to shore in slow speed , recharge battery and race again. don't keep racing boat when ESC low voltage cut off effective, otherwise, you will allow battery over discharge, battery voltage will reach very low and won't be recharged again.

IMPORTANT: THESE MODELS ARE CAPABLE OF OVER 60 KPH, PERSONAL INJURY OR PROPERTY DAMAGE MAY RESULT FROM MISUSE OF THESE PRODUCTS, TAKE CARE AND ENJOY OUR MODEL RESPONSIBLY.

Introduction

Thank you for purchasing Joysway brushless motor boat ! This manual contains the instructions you need to safely prepare, operate, and maintain your R/C boat. Read over this manual thoroughly before operating Joysway brushless motor boat.

Safety Precautions

- Operating care to avoid touching the propeller anytime the motor is operating. If your fingers, hands, etc. come in contact with the spinning propeller, you may be severely injured. This model is capable of inflicting property damage and severe personal injury if a collision occurs. Racing your boat responsibly, stay clear of people, full-scale boats and wildlife.
- The metal hardware on your boat can be sharp. Be careful handling the parts.
- The brushless motor may become hot. After a run allow the motor to cool before touching it.

Specifications & Description Changes

All pictures, descriptions, and specifications found in this instruction manual are subject to change without notice. Joysway maintains no responsibility for inadvertent errors in this manual.

Items Required For Completion & Battery Pack Recommendations

You will need to purchase the following items to operate your Joysway brushless motor boat. We highly recommend the use of the following products.

Battery Recommendation

7.4V 4000mAh 35C Lipo battery pack (need 2 packs, series connection)

NOTE If you have existing 7.4 V Lipo battery packs, you can update them for use by changing the connectors to XT-60 connectors which are included in the kits bag, be sure to solder the connectors to the batteries in the proper polarity. (2 XT-60 connectors are already soldered with the ESC, the other 2 XT-60 connectors are included in the kits bag)

Charger Recommendation

2S/3S Balance Charger and adapter, or multi-functional intelligent charger.

NOTE: You will also need 4 "AA" alkaline batteries for the transmitter.

Contents Of Set

- Water cooled 2815 out-runner brushless motor(included) (Pre-installed) **kits bag contents:**
- 60A Water cooling Brushless ESC w/BEC(Pre-installed)
- Powerful Steering 37g Servo (Pre-installed)
- 2.4GHz 2CH Pistol Transmitter
- Display Boat Stand

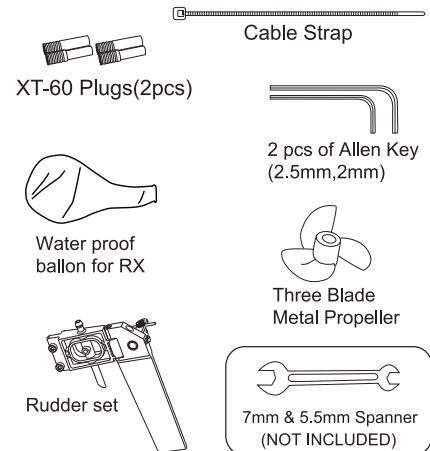
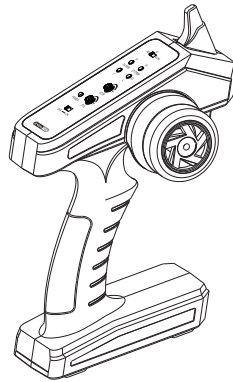
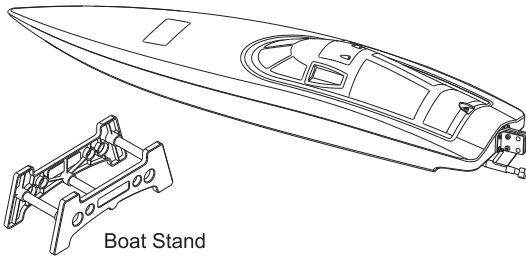

Circuit & Cooling System Diagram

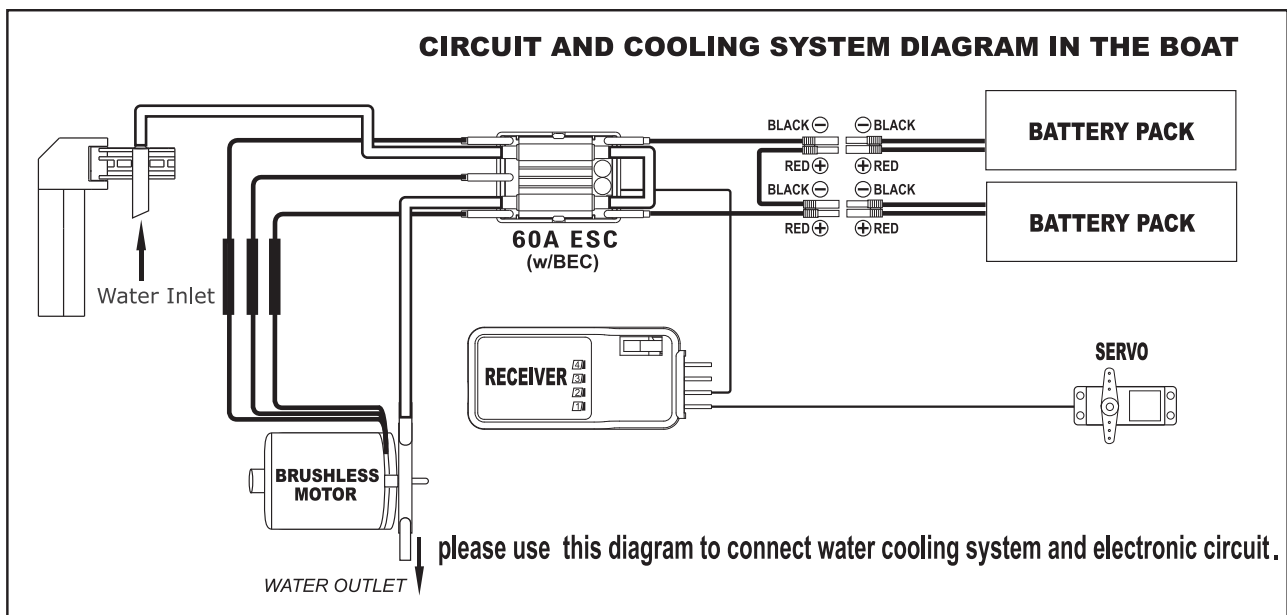

Preparing Your Boat For Operation

Assembling the boat stand

Insert three ABS pipes into the holes of two boat stands shown as photos, compress boat stands and ABS pipes tightly, then stick EVA to the four angles, this will protect the hull bottom from scratches during construction and storage.

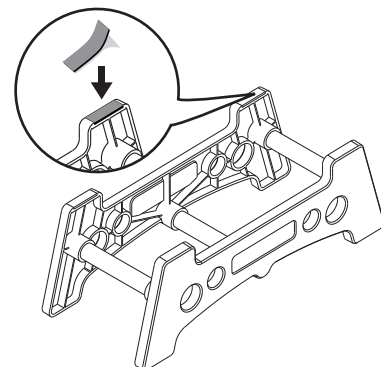

Bullet Rudder & Propeller Installation

1. Take out aluminum rudder, set screw and rudder metal mount pin from tool bag.
2. Rudder pushrod get through clevis, align rudder with rudder support, push in the rudder metal mount pin . to secure rudder in position, use allen key to tighten set screw to secure rudder with support. lastly, tighten the screw on the clevis.
3. Loose the screw on the propeller shaft by 7mm spanner, put the propeller in then tighten the screw.



Rescue Plastic Rudder

Bullet & Big Storm include one pc of rescue PVC rudder plate in the tool bag, This is installed by end user himself. If end user want to race this boat aggressively in rough wave, there is more chance boat will capsize. This rudder plate will perform as steering rudder in water, propeller roate to push boat back to shore. See belowing photo to install the rescue PVC rudder plate easily by tighten two screws only.

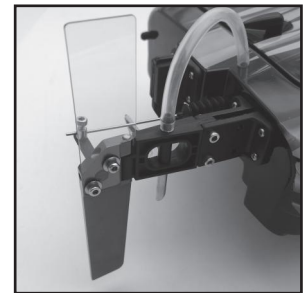

Rudder Assembly For Big Storm Catamaran

NOTE: Please install rudder and support on the right support which is pre-installed on the rear of hull in factory. Installing rudder and support on the right side is effective for good performance and stability.

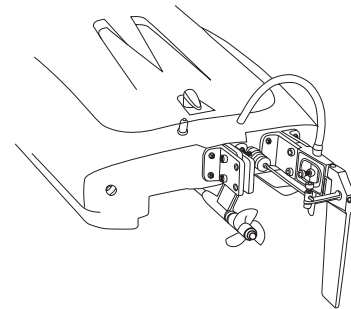

Installing the transmitter

NOTE: The transmitter is not water resistant and should never come in contact with water.

1. Install four fresh "AA" batteries. Follow the diagram located in the bottom of the battery tray for prope battery orientation.
2. Turn the transmitter "ON" The battery light should glow bright RED.

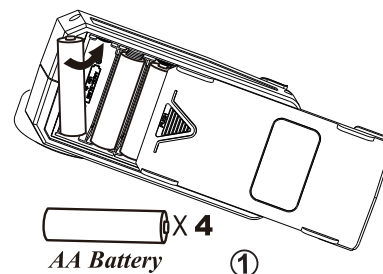

AA Battery X 4

①

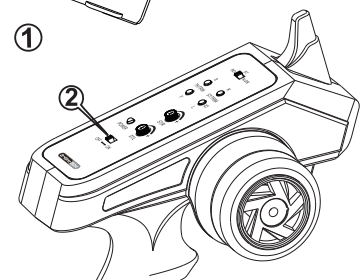

Receiver connection diagram

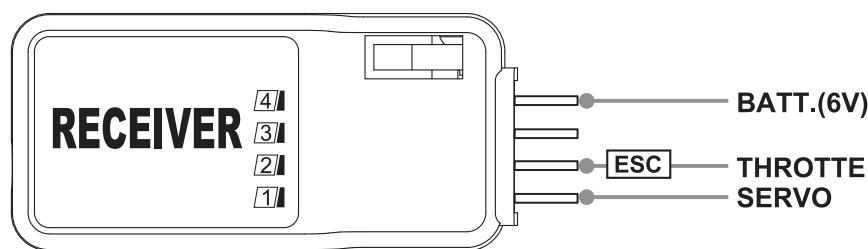

Note: If ESC with BEC function, no need to connect battery with receiver.

Caution: Before racing boat,
Please use ballon supplied
in tool bag to wrap receiver
for water proof

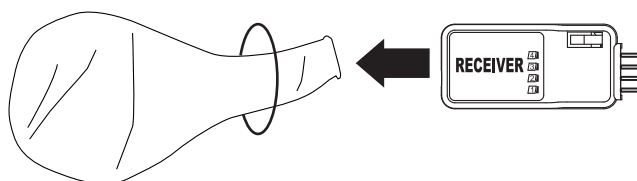

Installing the Battery

NOTE: We recommend you 2 packs of 7.4V 4000mAh 35C Lipo battery for maximum performance. Using the Provided Hook and Loop which are already tied on the battery locators inside the hull to tie the battery. The battery locators help align the batteries for the best running center of gravity for maximum performance. Below are the batteries location inside the hull.



Bullet Deep Vee

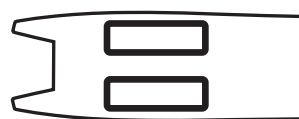

Big Storm Catamaran

NOTE: 1. There is a water proof rubber ring placed along the slot of hull, always make sure it's secured positioned before re-position the upper deck.

TRANSMITTER/RECEIVER BINDING

The binding process effectively ties the transmitter and receiver together. Under normal circumstances, both items are supplied like this from the factory. If, however, you find that your transmitter and receiver are not bound(receiver's red LED is on), you should do the following:

- 1) Switch "ON" the transmitter.
- 2) Switch "ON" the receiver by connecting battery to ESC, and ESC cord is plug into Receiver properly(Note:ESC has BEC function).
- 3) Press down the "BIND" button on the receiver, the receiver's green LED will be on to indicate that binding has been successful and the receiver will now accept commands from the transmitter.

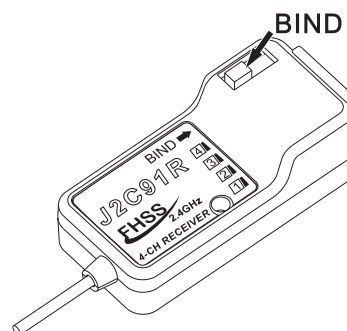

Note 1: During binding process, transmitter and receiver should be no more than one meter apart and no other similar devices should be within 10 meters.

Note 2: if the green light flashing, showing the binding failure, please do again as above indication.

Checking the radio system

1. Always turn the power "ON" to the transmitter before connecting the batteries with the ESC.
2. Plug the battery into the ESC plugs and listen for three continuous >Be<>Be<>Be< . (Signal noise of auto etected ESC)
3. Pull the throttle & motor rotate in anticlockwise direction, your motor is now armed and ready for operation.
4. Check the direction of the rudder, the trailing edge of the rudder should turn right when right input is given. Conversely, when left input is given, the trailing edge of the rudder should turn left.

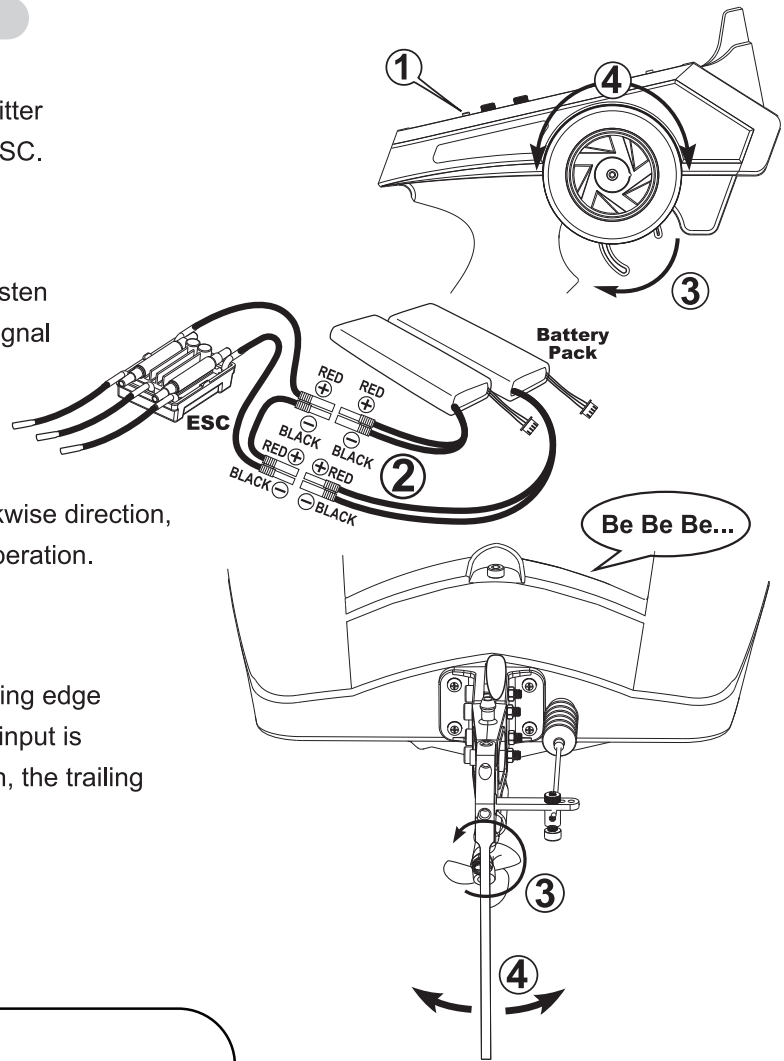

Transmitter introduction

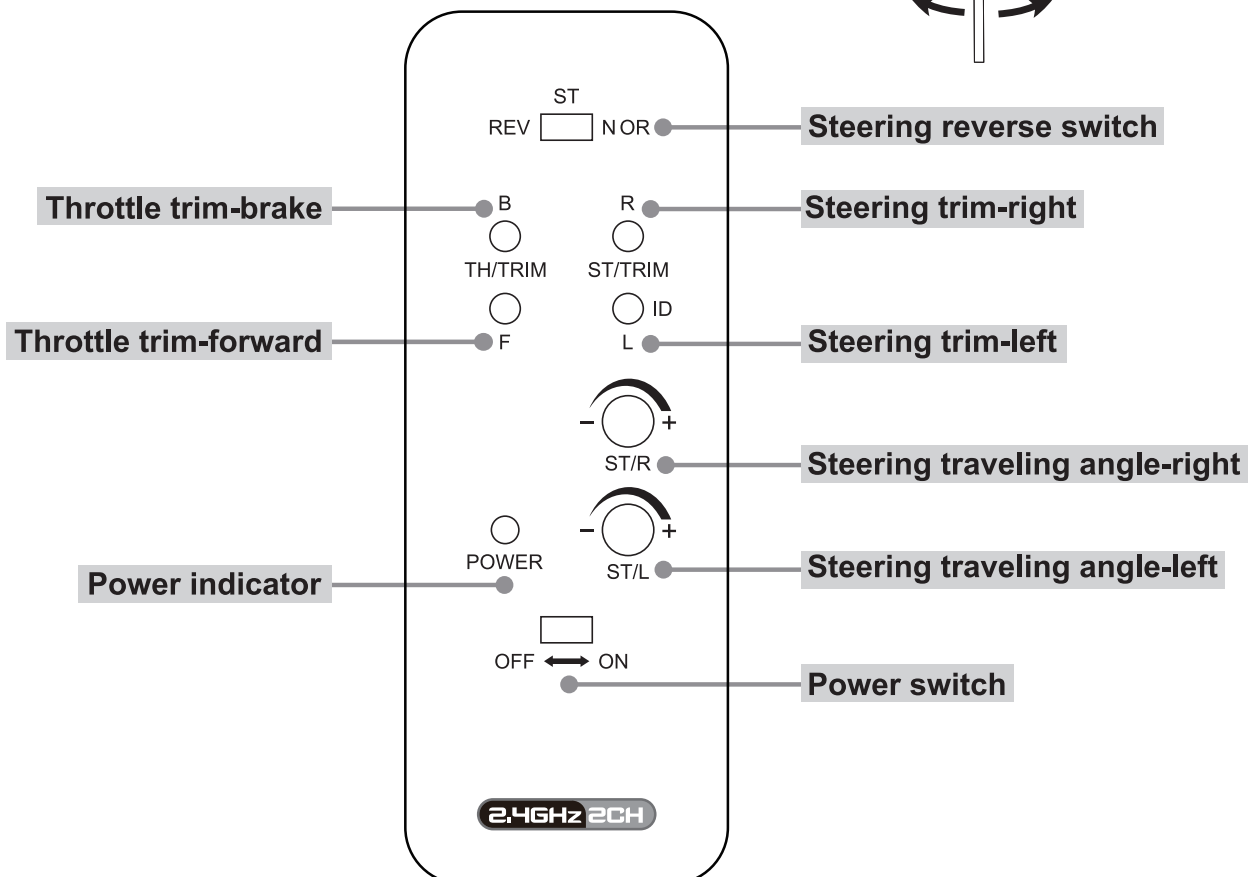

EPA Adjustment

Function

Use this when performing left and right steering angle adjustments. End Point Adjustment (EPA) adjusting value range: 0%-100%

Setting

1. Steering (right side) angle adjustment Rotate "ST/R" knob to the left end point means minimum value 0%, right end point means maximum value 100%.
2. Steering (left side) angle adjustment Rotate "ST/L" knob to the left end point means minimum value 0%, right end point means maximum value 100%.

CAUTION:

When adjusting this function, make sure the direction is in agreement with the boat direction, you can adjust by the STEERING "REV-NOR" button.

Steering reverse switch

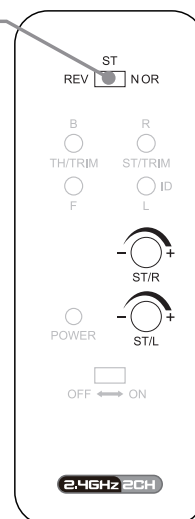
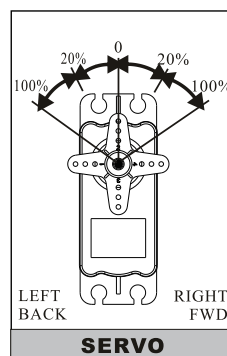

Trim Adjustment

Steering trim

Adjust "ST/TRIM" "R/L" so that rudder is centered prior to operation, you may adjust this control to make the boat run straight during operation.

CAUTION:

When adjusting steering trim, make sure the direction is in agreement with the boat direction, you can adjust by the STEERING "REV-NOR" button.

Throttle trim

Adjust "TH/TRIM" "B/F" to stop propeller from turning while the throttle trigger is in the neutral position.

Steering reverse switch

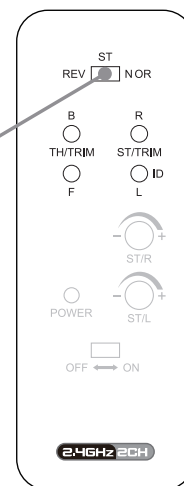

Speed Control Specification

The Joysway brushless motor boat is assembled with 60A water cooled brushless ESC, please see belowing the specification:

protections: Thermo protection activated at 120°C. LVP(low voltage protection) engaged when Lipo battery (per cell) drop down to 3.2 Voltage.

Operating Cells: 2S - 4S Lipo

Current Rating: 60A

Peak Current: 70A within 10 seconds.

BEC Output: 2A / 5V

Calibration: 1. Ser the trigger to maximum throttle then turn on the transmitter.

2. Connect motor and receiver to the ESC.

4. After 4 high pitched tones, set the trigger to minimum throttle.

5. After 3 repeat monotones, cut off the power of ESC.

Lubricating The Drive Shaft

Lubricating the flexshaft is vital to the life of the drivetrain. The lubricant also acts as a water seal, keeping water from entering the hull through the stuffing box.

Lubricate the flexshaft, propeller shaft and all moving parts after every 2–3 hours of operation.

1. Use the 2mm Allen key to loose the two grub screws of the coupler which connects the flexshaft, then slide the flexshaft w/ prop shaft out of the stuffing tube.

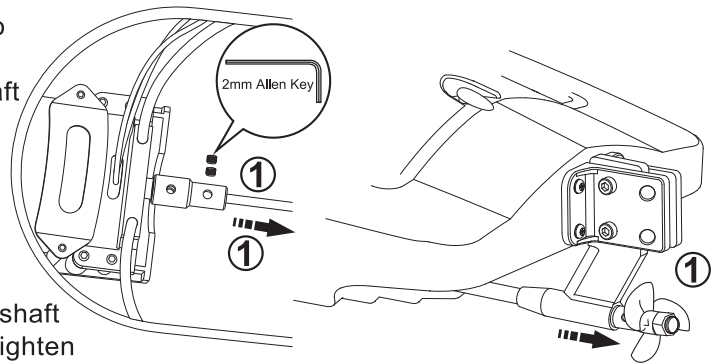

2. Lubricate the flexshaft w/ prop shaft with the water proof marine grease, reinstall the flexshaft w/ prop shaft in reverse order, be sure to retighten the two grub screws of coupler.

NOTE: Running the model boat in salt water could cause some parts to corrode. If you run the boat in salt water, rinse it thoroughly in fresh water after each use and lubricate the drive system.

Spare part list

To order Joysway brushless motor boat spare parts, use the part numbers in the spare parts list that follows.

PART NO.	DESCRIPTION
83002	Bullet V4 water proof rubber ring (PK2)
83004	Big Storm water proof rubber ring (PK2)
83013	Big Storm Aluminum alloy rudder assembly set
83014	37g standard servo
83016	Rudder clevis (PK2)
830107	BL2815 Out-runner brushless motor with 4mm gold plug
830108	Coupler(4mm) of BL2815 motor
830110	Rear shaft strut support set
830117	Water cooling mount of BL2815 motor
830119	7.4V 4000mAh 35C LiPo Pack with XT-60 plug
830122	60A Water Cooled Brushless ESC With XT-60 plugs
830123	P1.4X37mm Three Blade metal Propeller- 8301V3 & 8303
830124	Bullet V4 Aluminum alloy rudder & Support set(2022)
830125	Bullet V4 Aluminum alloy Support for Rudder(2022)
830126	Bullet V4 4mm Flex shaft set(2022)
830127	Bullet V4 Connected rod of Rudder(2022)
830202	Big Storm 4mm Flex shaft set
830203	Big Storm Connected rod of Rudder
93017	Water-proof rudder pushing rod tube(PK2)
930518	J2C93 2.4GHz 2CH Transmitter
930519	J2C91R 2.4GHz 4CH Receiver
610212	2S/3S balance charger & EU plug AC power cable
820514	2S/3S balance charger & UK plug AC power cable
820515	2S/3S balance charger & US plug AC power cable
820516	2S/3S balance charger & AU plug AC power cable



FCC REQUIREMENT



This device complies with Part 15 of the FCC Rules. Operation is subject to the following two conditions: (1) This device may not cause harmful interference, and (2) This device must accept any interference received, including interference that may cause undesired operation.

CAUTION: Changes or modifications to this product not expressly approved by the party responsible for compliance may void the user's authority to operate the equipment.